

# Dimplex



BACH

08/50630/3 (UK) Issue 3

 The product complies with the European Safety Standards EN60335-2-30 and the European Standard Electromagnetic Compatibility (EMC) EN55014, EN60555-2, EN60555-3. These cover the essential requirements of EEC Directives 2006/95/EC and 2004/108/EC.

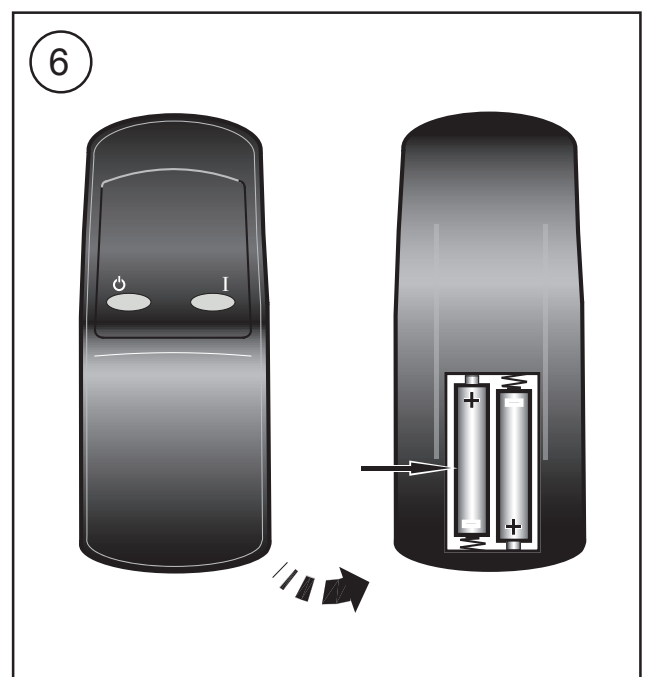
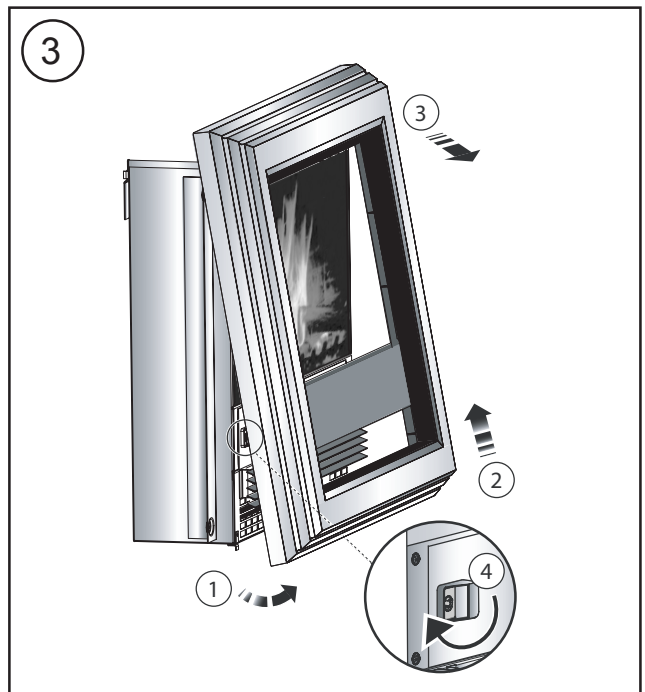
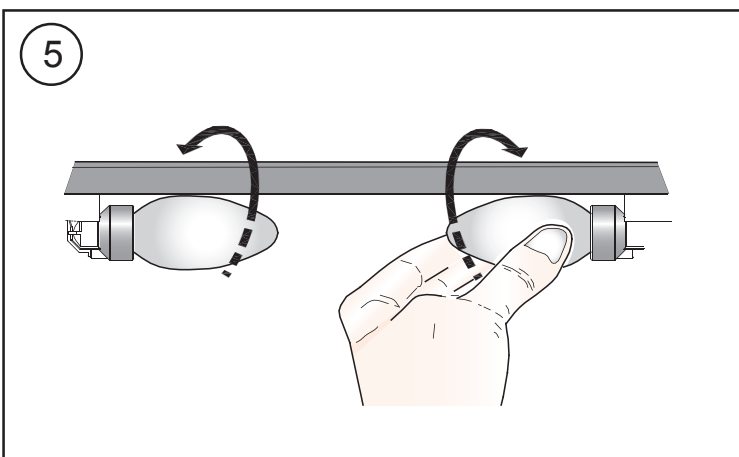
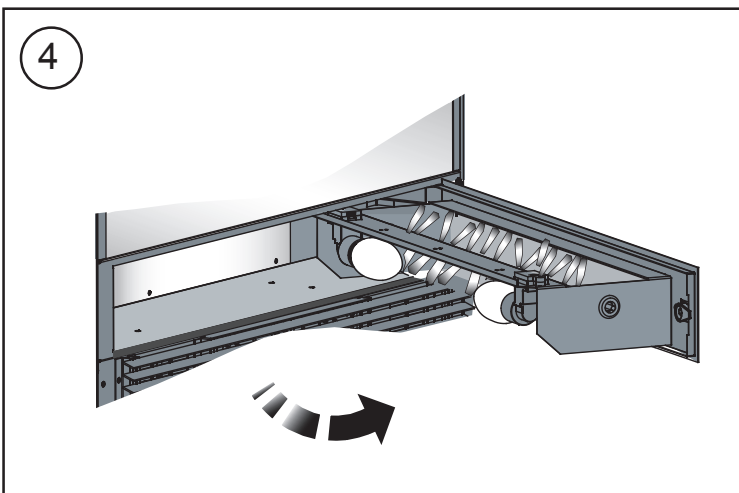
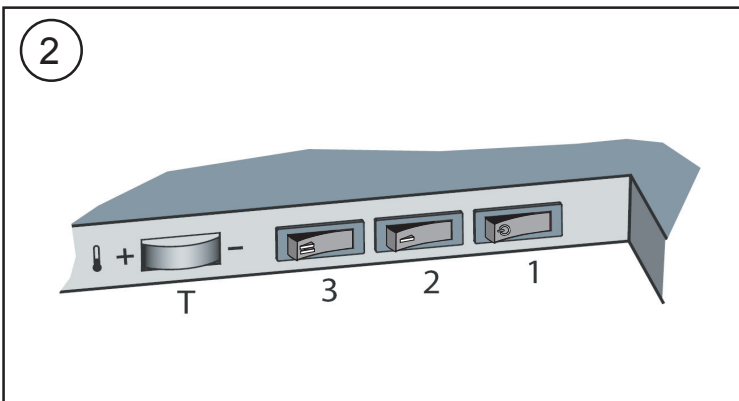
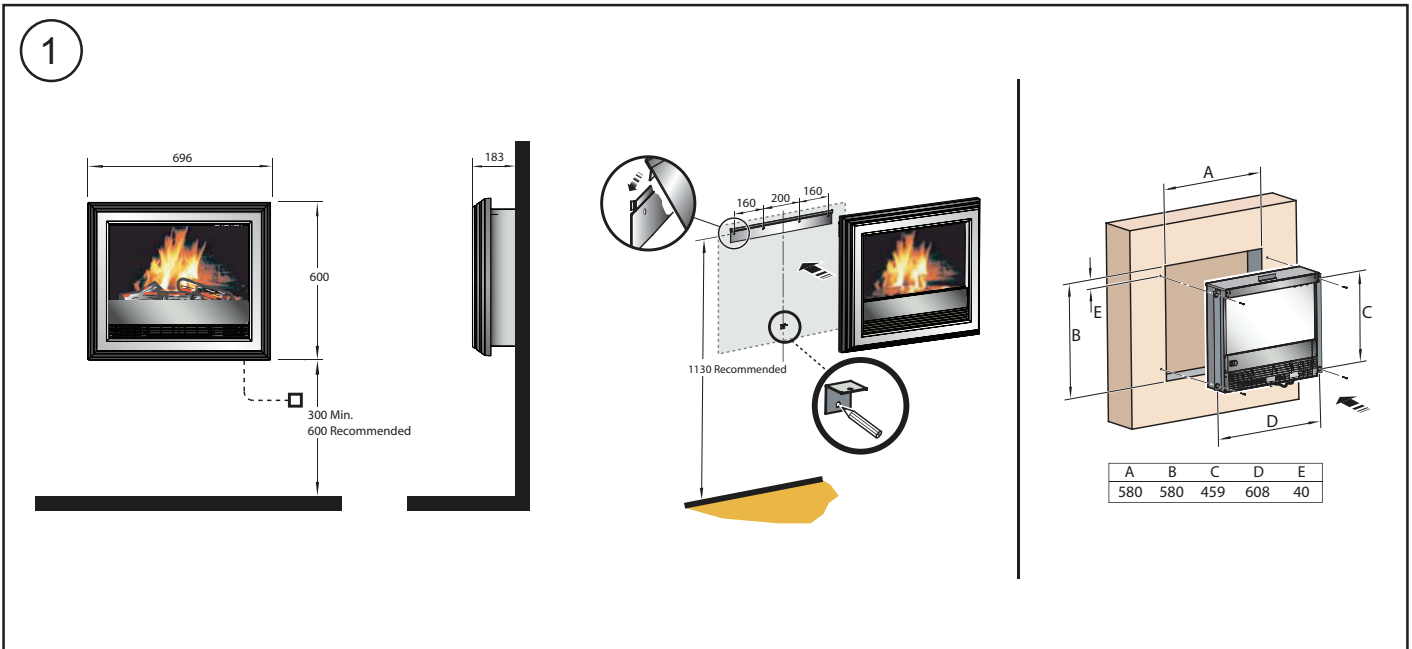

# BACH Wall Fire

IMPORTANT: THESE INSTRUCTIONS SHOULD BE READ CAREFULLY AND RETAINED FOR FUTURE REFERENCE

## Important Safety Advice

When using electrical appliances, basic precautions should be followed to reduce the risk of fire, electric shock, and injury to persons, including the following:

If the appliance is damaged, check immediately with the supplier before installation and operation.

Do not use this heater in the immediate surroundings of a bath, shower or swimming pool.

Do not use outdoors.

This heater must not be located immediately above or below a fixed socket outlet or connection box.

Do not cover or obstruct in any way the heat outlet grille located underneath the heater. Overheating will result if the heater is accidentally covered.

In the event of a fault unplug the heater.

Unplug the heater when not required for long periods.

The supply cord must be placed on the right hand side of the heater away from the heat outlet underneath the heater.

Although this heater complies with safety standards, we do not recommend its use on deep pile carpets or on long hair type of rugs.

This appliance is not intended for use by children or other persons without assistance or supervision if their physical, sensory or mental capabilities prevent them from using it safely. Children should be supervised to ensure that they do not play with the appliance.

The appliance must be positioned so that the plug is accessible.

If the supply cord is damaged it must be replaced by the manufacturer or service agent or similarly qualified person in order to avoid a hazard.

**Caution:** In order to avoid a hazard due to inadvertent resetting of the thermal cut-out, this appliance must not be supplied through an external switching device, such as a timer, or connected to a circuit that is regularly switched on and off by the utility.

The appliance must not be located beneath a socket outlet.

Where an appliance is Recessed, necessity to allow disconnection of the appliance from the electrical supply is required. Incorporate a switch in the fixed wiring in accordance with the Wiring regulations.

## General

Unpack the heater carefully and retain the packaging for possible future use, in the event of moving or returning the fire to your supplier.

The fire incorporates a flame effect, which can be used with or without heating, so that the comforting effect may be enjoyed at any time of the year. Using the flame effect on its own only requires little electricity.

Before connecting the heater check that the supply voltage is the same as that stated on the heater.

Please note: Used in an environment where background noise is very low, it may be possible to hear a sound which is related to the operation of the flame effect. This is normal and should not be a cause for concern.

## Electrical

### WARNING – THIS APPLIANCE MUST BE EARTHED

This heater must be used on an AC ~ supply only and the voltage marked on the heater must correspond to the supply voltage.

Do not switch the appliance on until properly installed. Please read all the safety warnings and operating instructions.

## Wall fixing - see Fig. 1

The appliance should be securely fixed to the wall using the wall plugs and screws supplied for block walls.

Note – for studded walls special fasteners are required, see diagram for recommended position of fixing screws.

## Recessed Installation

Please note that this appliance can also be wall-mounted so that it is recessed. This can be installed in a large fireplace opening or a purpose built wall. See Fig. 1 for size of recess required and hole fixing dimensions. This fireplace insert does NOT require venting.

**In order to ensure it's future safety in use, it is essential that this fire is securely fixed to the wall.**

IT IS IMPORTANT THAT THE FIXING DEVICE CHOSEN IS APPROPRIATE TO THE WALL MATERIAL TO WHICH THE FIRE IS BEING FIXED. SOME MODERN INTERNAL BUILDING MATERIALS ARE VERY LOW DENSITY BLOCK AND REQUIRE SPECIALIZED FIXING DEVICES TO PROVIDE A SAFE, SECURE INSTALLATION.

The installation of this fire should be carried out by a competent person. If in doubt please consult your local builder.

This section provides step by step instructions for selecting a location and preparing the site to install the fireplace into the following:

## Existing Fireplace

1. Make sure that the fire is located on a flat surface.
2. Seal all draughts and vents to prevent chimney debris from falling onto the Fireplace Insert. Do not install into an existing fireplace that is prone to dampness.
3. Remove the front/trim by following the steps as outlined in 'Lamp Replacement' section.
4. Locate the 4 fixing holes, position the fire accordingly, and firmly fix the appliance to the wall using the appropriate screws.
5. Replace the front/trim.

## New Support Structure Construction

When planning where to position your purpose built support structure the following steps must be observed:

1. Place the fire in the desired location to see how it will look in the room.
2. Mark the desired location for the new support structure in the room and store the fire in a safe, dry and dust free location.
3. Using timber studs to support the fire, devise and construct a suitable means of supporting the product within the wall partition and provide electrical power for the fire to be HARD wired. For recommended sizes of height, width and depth of opening for recess and hole fixing dimensions for each model - see Fig. 1.
4. Remove the front/trim by following the steps as outlined previously.
5. Locate the 4 fixing holes, position the fire accordingly, and firmly fix using the appropriate screws.
6. Replace the front/trim.

NOTE: The appliance should be HARD wired to an electrical power outlet when placed in a recessed installation.

Please consult a qualified electrician for appropriate wiring requirements.

## Controls - see Fig. 2

Three switches provide a choice of heat settings. The appliance is in standby mode when the mains lead is plugged in. This is indicated by the red neon behind the flame effect screen. The two selector switches are in the ON position when the side with the markings on (i.e. I, or II) are pushed in.

Push button switch 1  Controls the electricity supply to the heater and flame effect. Press for 'ON' and 'Standby'. If both selector switches 2 and 3 are in the OFF position, the product works on flame effect only.

Selector switch 2 (I) Provides 1kW heat output.

Selector switch 3 (II) Provides 2kW output with switch 2.

## Thermostat (T) - see Fig. 2

In order to maintain a certain room temperature, set the controller to 'max.'. Operate the appliance at full power until the required room temperature is reached. Set back the thermostatic controller until the appliance switches off with an audible 'click'. This temperature will be kept almost constant by the thermostatic control switching on and off automatically. Please note that the appliance can only be switched on when the thermostat setting is higher than the room temperature.

## Remote control - see Fig. 6

The maximum range of use is ~ 15metres.

Warning: It takes time for the receiver to respond to the transmitter.

Do not press the buttons more than once within two seconds for correct operation.

## Battery information - see Fig. 6

1. Slide open the battery cover on the back of the remote control
2. Install AAA batteries into the remote control
3. Replace the battery cover.

### Discard leaky batteries

Dispose of batteries in the proper manner according to provincial and local regulations.

Any battery may leak electrolyte if mixed with a different battery type, if inserted incorrectly, if all the batteries are not replaced at the same time, if disposed of in a fire, or if an attempt is made to charge a battery not intended to be recharged.

## Thermal Safety Cut-out

A thermal safety cut-out is incorporated in the heater to prevent damage due to overheating. This can happen if the heat outlet was restricted in any way. The heater will switch on once the obstruction has been removed and the heater has cooled. If the cut-out continues to operate intermittently, the heater should be switched off and a service agent contacted.

## Maintenance

**WARNING: ALWAYS DISCONNECT FROM THE POWER SUPPLY BEFORE ATTEMPTING ANY MAINTENANCE.**

## Lamp Replacement - see Fig. 3, Fig. 4 and Fig. 5

Remove front cover.

Using a coin edge or screwdriver turn catch 1/4 turn clockwise. Pull the tray forward, the bulbs can now be replaced with a 60W E14 SES Clear Candle lamp.

Take care not to over-tighten the lamp

## Cleaning

**WARNING – ALWAYS DISCONNECT FROM THE POWER SUPPLY BEFORE CLEANING THE HEATER.**

For general cleaning use a soft clean duster – never use abrasive cleaners. The glass viewing screen should be cleaned carefully with a soft cloth. DO NOT use proprietary glass cleaners.

To remove any accumulation of dust or fluff the soft brush attachment of a vacuum cleaner should occasionally be used to clean the outlet grille of the fan heater.

## Recycling

For electrical products sold within the European Community.



At the end of the electrical products useful life it should not be disposed of with household waste. Please recycle where facilities exist. Check with your Local Authority or retailer for recycling advice in your country.

## After Sales Service

Your product is guaranteed for one year from the date of purchase.

Within this period, we undertake to repair or exchange this product free of charge (*excluding lamps & subject to availability*) provided it has been installed and operated in accordance with these instructions.

Your rights under this guarantee are additional to your statutory rights, which in turn are not affected by this guarantee.

Should you require after sales information or assistance with this product please go to [www.dimplex.co.uk](http://www.dimplex.co.uk) where you will find our self help guide by clicking on 'After Sales' or ring our help desk on 0845 600 5111 (UK) or 01 842 4833 (R.O.I.).

Spare parts are also available on the website [www.dimplex.co.uk](http://www.dimplex.co.uk)

Please retain your receipt as proof of purchase.